

Enodis

Machine à glaçons à aspersion

ES28+

Glaçons pleins

28kg / 24h - 230V/1N/50Hz



Type de glace

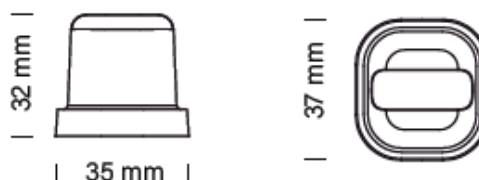

Caractéristiques

- Construction en acier inox
- Version à air ou à eau
- Cycle de nettoyage
- Panneau de contrôle touch
- Alarme acoustique et lumineuse
- Report alarmes HACCP
- Réglage du poids du glaçon
- Réglage du niveau de la glace du réservoir
- Clé USB pour mise à jour logicielle et téléchargement des données HACCP
- Analytique prédictive des dysfonctionnements
- Report des performances

Options

- Kit pieds
- Désinfection à l'Ozone
- Rainbow Technologie traitement évaporateur
- Pompe de vidange externe

Cycle

18 pcs/cycle

Poids du glaçon

20 g

Capacité de stockage

7,0 kg - 350 pcs

Enodis

Machine à glaçons à aspersion

ES28+

Vues

Vue frontale
Front view

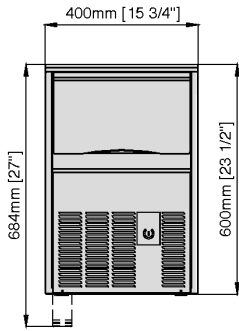

Vue latérale
Side view

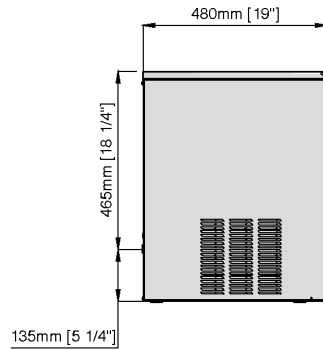

Vista de dessus
Top view

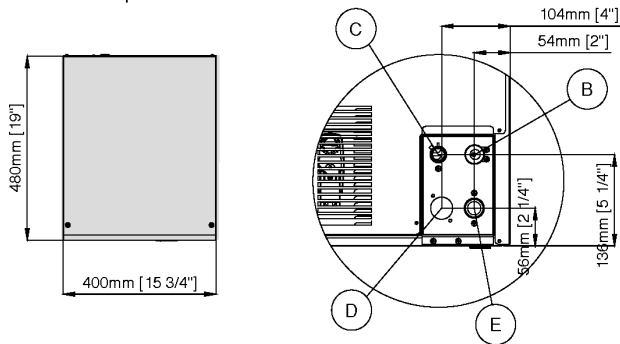

- B** Alimentation électrique Electrical cable supply
- C** Drainage de l'eau Ø 20 mm Water outlet connection Ø 20 mm
- D** Sortie de l'eau condensation à eau Ø20mm Water outlet connection water condensation Ø20mm
- E** Entrée de l'eau 3/4" gas Water inlet connection 3/4" gas



TOUCH CONTROL

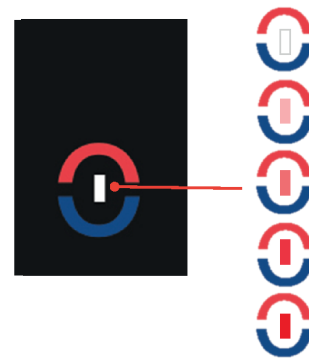

Bouton Capacitif de réinitialisation Stand-by (led à variation continue de couleurs du blanc au rouge)

Capacitive Stand-by Reset button (led with continuous colors variation from white to red)

CONDITIONS DE TRAVAIL - OPERATING REQUIREMENTS

	Min.	Max
Témp. Ambiante / Air Temperature	10°C	40°C
Témp. Eau / Water Temperature	5°C	35°C
Press. eau / Water Pressure	1 Bar (14psi)	5 Bar (70psi)
Conductivité eau / Water conductivity	-- µS	-- µS
Voltage / Electrical supply	-10%	+10%

Chaleur expulsé / Rejected Heat	947 W
Volume Air / Air Volume	185 m3/h

Enodis

Machine à glaçons à aspersion

ES28+

Dimensions

 LxPxH (mm) : 400 x 480 x 600

 LxPxH (mm) : 460 x 600 x 850











Voltage

 220-240/50/1
220/60/1

Gaz

 R290 / GWP = 3 / Ton CO2 equiv. = 0

Données techniques

		 cond.	 comp. W	 ABS. W	 fuse	 kwh/100kg	 l/h	 kg	 kg
ES28+ A	220-240/50/1		653	310	10	36.6	2.6	30	35
ES28+ W	220-240/50/1		653	280	10	22.8	38.7	30	35

Production glace / 24h

Condensation à air

Température de l'air	Température de l'eau			
°C	32°	21°	15°	10°
10°	20	24	26	28
21°	18	22	23	25
32°	15	19	20	22
38°	13	16	17	18

Condensation à eau

Température de l'air	Température de l'eau			
°C	32°	21°	15°	10°
10°	20	24	26	28
21°	19	23	25	27
32°	18	22	24	26
38°	16	18	20	21