

Enodis

Machine à glaçons à aspersion

ES70

Glaçons pleins

70kg / 24h - 230V/1N/50Hz

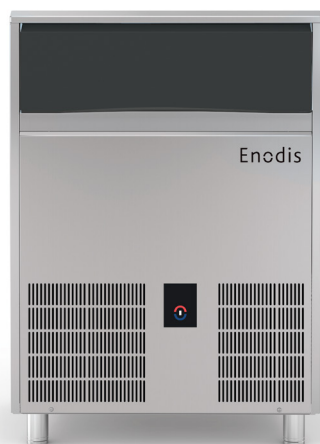

Type de glace

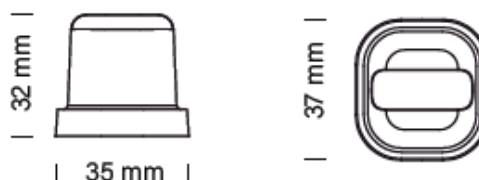

Caractéristiques

- Construction en acier inox
- Version à air ou à eau
- Cycle de nettoyage
- Panneau de contrôle touch
- Alarme acoustique et lumineuse
- Report alarmes HACCP
- Réglage du poids du glaçon
- Réglage du niveau de la glace du réservoir
- Clé USB pour mise à jour logicielle et téléchargement des données HACCP
- Analytique prédictive des dysfonctionnements
- Report des performances
- Kit pieds

Options

- Désinfection à l'Ozone
- Rainbow Technologie traitement évaporateur
- Pompe de vidange externe

Cycle

56 pcs/cycle

Poids du glaçon

20 g

Capacité de stockage

42,0 kg - 2100 pcs

Enodis

Machine à glaçons à aspersion

ES70

Vues

Vue frontale
Front view

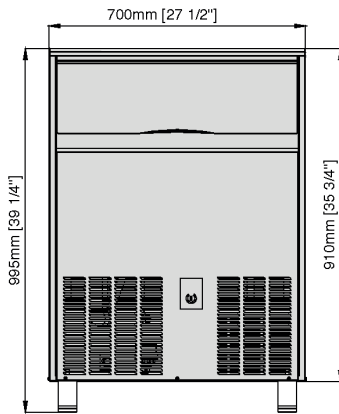

Vue latérale
Side view

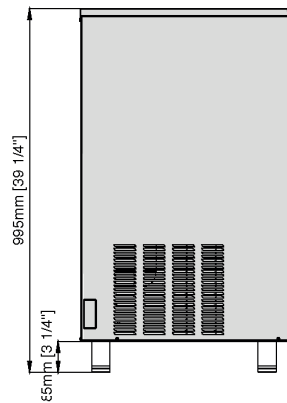

Vista de dessus
Top view

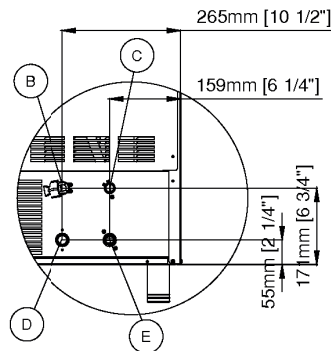
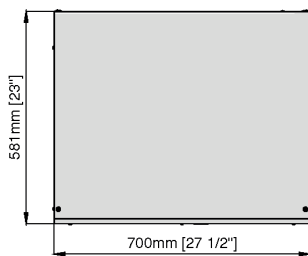

- B** Alimentation électrique Electrical cable supply
- C** Drainage de l'eau Ø 20 mm Water outlet connection Ø 20 mm
- D** Sortie de l'eau condensation à eau Ø20mm Water outlet connection water condensation Ø20mm
- E** Entrée de l'eau 3/4" gas Water inlet connection 3/4" gas

TOUCH CONTROL

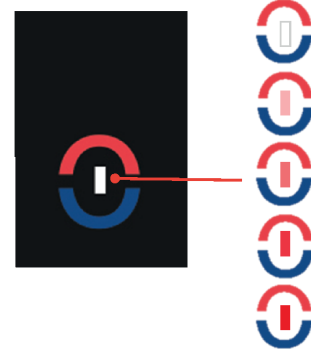

Bouton Capacitif de réinitialisation Stand-by (led à variation continue de couleurs du blanc au rouge)

Capacitive Stand-by Reset button
(led with continuous colors variation from white to red)

CONDITIONS DE TRAVAIL - OPERATING REQUIREMENTS

	Min.	Max
Témp. Ambiante / Air Temperature	10°C	40°C
Témp. Eau / Water Temperature	5°C	35°C
Press. eau / Water Pressure	1 Bar (14psi)	5 Bar (70psi)
Conductivité eau / Water conductivity	-- µS	-- µS
Voltage / Electrical supply	-10%	+10%

Chaleur expulsé / Rejected Heat	1938 W
Volume Air / Air Volume	310 m3/h

Enodis

Machine à glaçons à aspersion

ES70

Dimensions

 LxPxH (mm) : 700 x 580 x 995

 LxPxH (mm) : 740 x 640 x 1080











Voltage

 220-240/50/1
220/60/1

Gaz

 R290 / GWP = 3 / Ton CO2 equiv. = 0

Données techniques

		 cond.	 comp.W	 ABS.W	 fuse	 kwh/100kg	 l/h	 kg	 kg
ES70 A	220-240/50/1		1315	620	10	20.9	10.3	53	62
ES70 W	220-240/50/1		1315	490	10	18.3	45.8	53	62

Production glace / 24h

Condensation à air

Température de l'air °C	Température de l'eau			
	32°	21°	15°	10°
10°	63	67	69	70
21°	57	61	63	65
32°	52	56	58	60
38°	42	45	47	49

Condensation à eau

Température de l'air °C	Température de l'eau			
	32°	21°	15°	10°
10°	64	71	73	75
21°	61	68	70	72
32°	59	64	68	70
38°	54	59	62	63